

FE208EΣ

Recommended Back Loaded Horn Type Enclosure

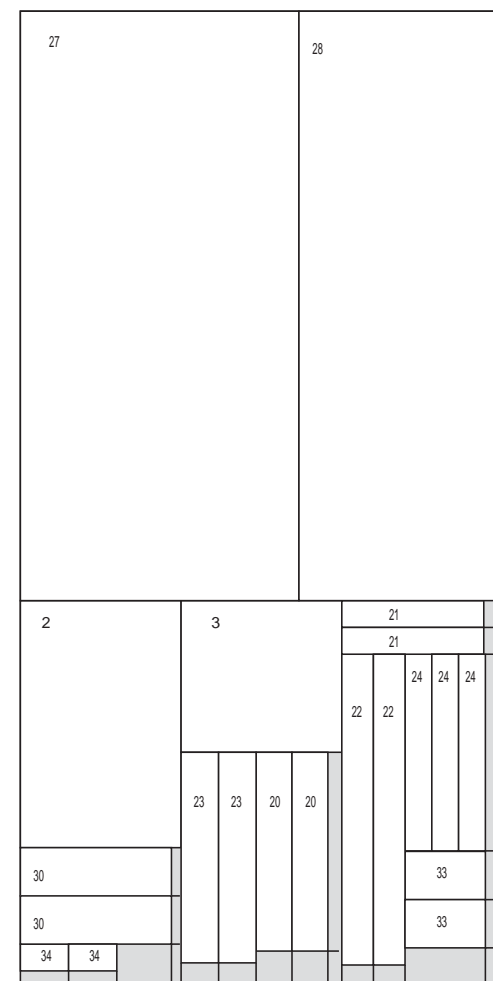

- This box plan is the full-fledged back loaded horn enclosure for FE208Esigma.
- Well tuned low frequency realizes tight and massive sound with perceptible fast response.
- Adding T900A super tweeter on this system, the briskness of mid-frequency gets better.

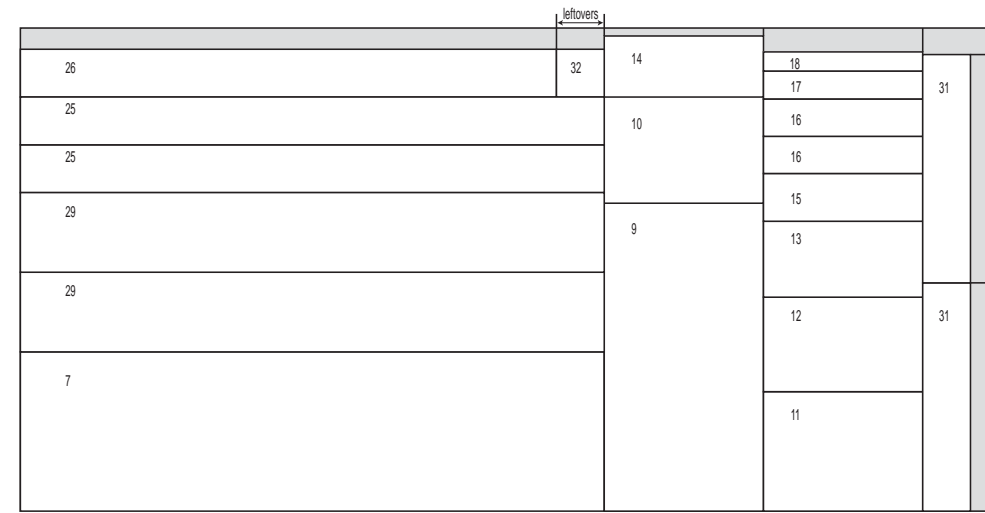
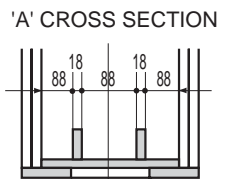
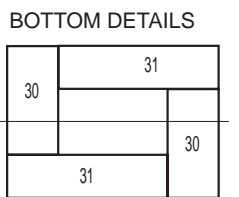
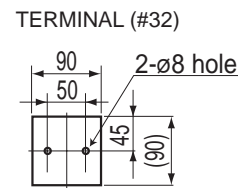
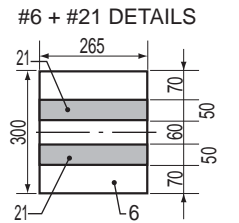
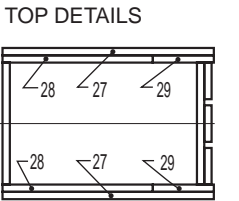
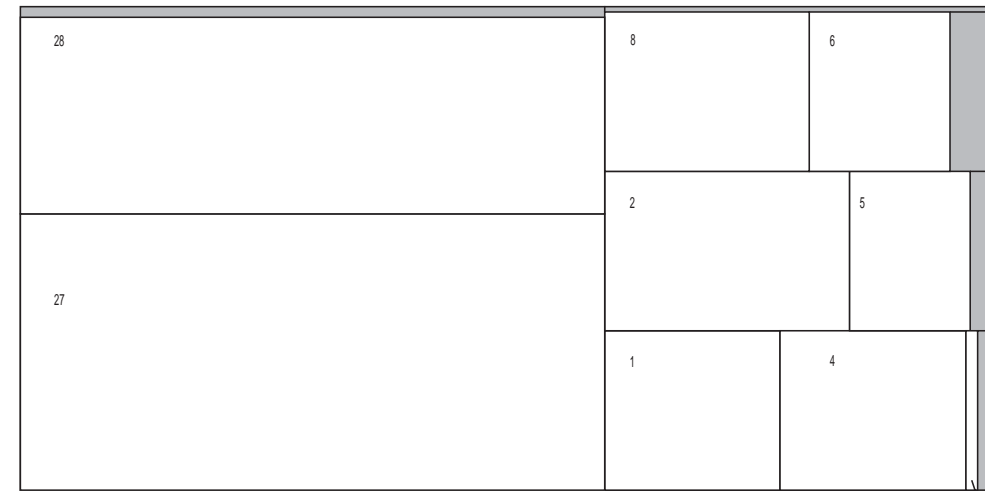
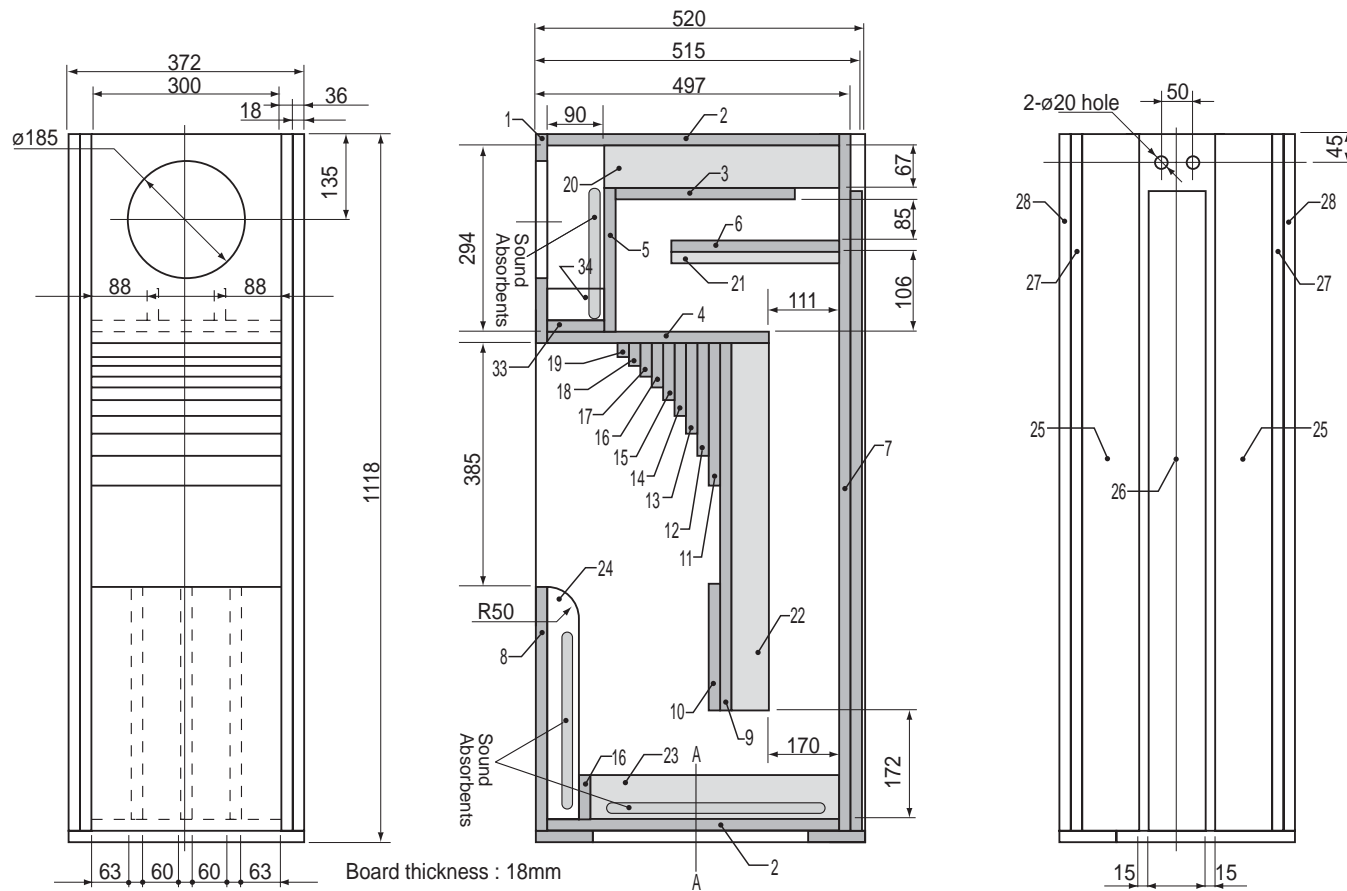
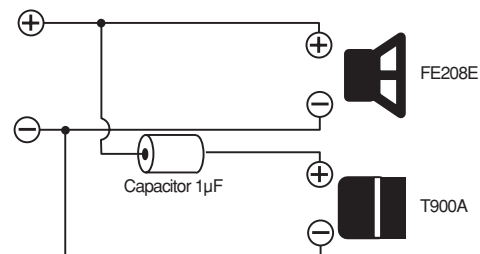

- This large-scaled enclosure brings the dynamic sound only the back loaded horn system would reproduce.

Cutting Size Chart (1set, unit:mm)

No.	Size (W x H)	Qty	No.	Size (W x H)	Qty
1	300 x 330	1	18	300 x 36	1
2	300 x 461	2	19	300 x 22	1
3	300 x 283	1	20	371 x 67	2
4	300 x 350	1	21	265 x 50	2
5	300 x 227	1	22	580 x 59	2
6	300 x 265	1	23	393 x 70	2
7	300 x 1100	1	24	367 x 50	3
8	300 x 385	1	25	1100 x 90	2
9	300 x 580	1	26	1010 x 90	1
10	300 x 200	1	27	1100 x 520	2
11	300 x 225	1	28	1100 x 370	2
12	300 x 178	1	29	1100 x 150	2
13	300 x 143	1	30	282 x 90	2
14	300 x 115	1	31	430 x 90	2
15	300 x 90	1	32	90 x (90)	1
16	300 x 70	2	33	150 x 90	2
17	300 x 53	1	34	90 x 50	2

Frequency Response

